

iAeris

iAeris5 Indoor Air Quality Detector



Closely review the user manual before using this product.

USER MANUAL

www.sysinnotec.com

**sysinno**

PACKAGE CONTENTS

- iAeris main unit
- Adapter
- Wall mounting screws
- Installation positioning diagram

PRODUCT DESIGN / FEATURES

Front View

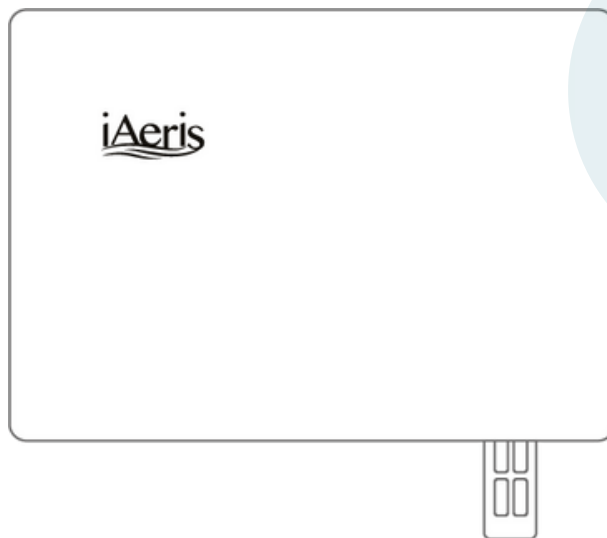

Back View

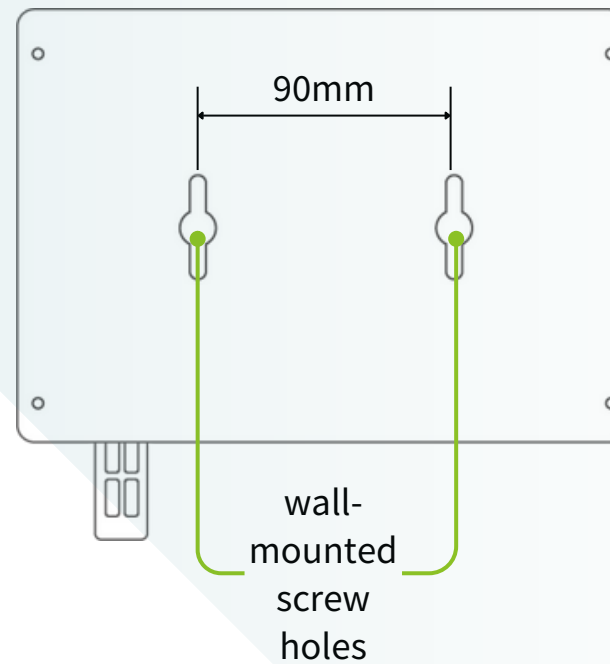

Adapter



PRODUCT DESIGN / FEATURES

Right View

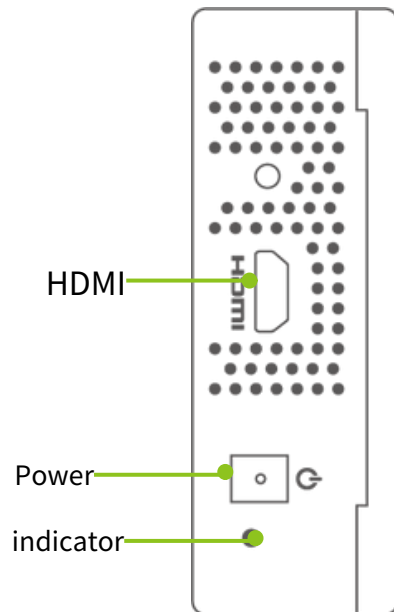

Top View

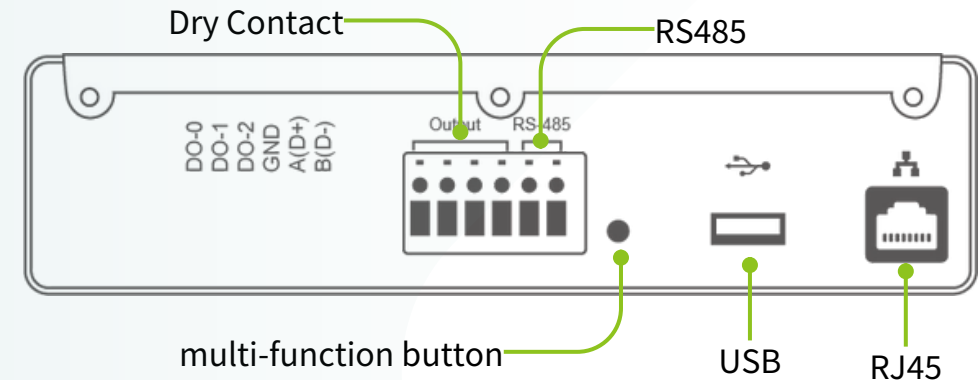

REMARKS:

[1] Communication Cable Recommendations:

RS485: AWG22 double-insulated control wire.

Dry Contact: AWG24~AWG19 multi-core power wire.

[2] This product supports IEEE802.3af PoE power supply specification (optional feature)

Communication Interface:

Dry Contact Functionality

- This product supports three sets of dry contacts for activating external devices.

RS485 Functionality

- RRS-485 has directionality, please pay attention to the positions of A(+) and B(-) when connecting.
- RS-485 communication adopts the Modbus-RTU format. Please use devices and equipment with Modbus-RTU Master functionality for communication.

Network Functionality

- For Ethernet, use RJ45 connector.
- For wireless, follow WiFi setup instructions.
- iAeris5 supports HTTP and MQTT network communication.

PRODUCT DIMENSIONS

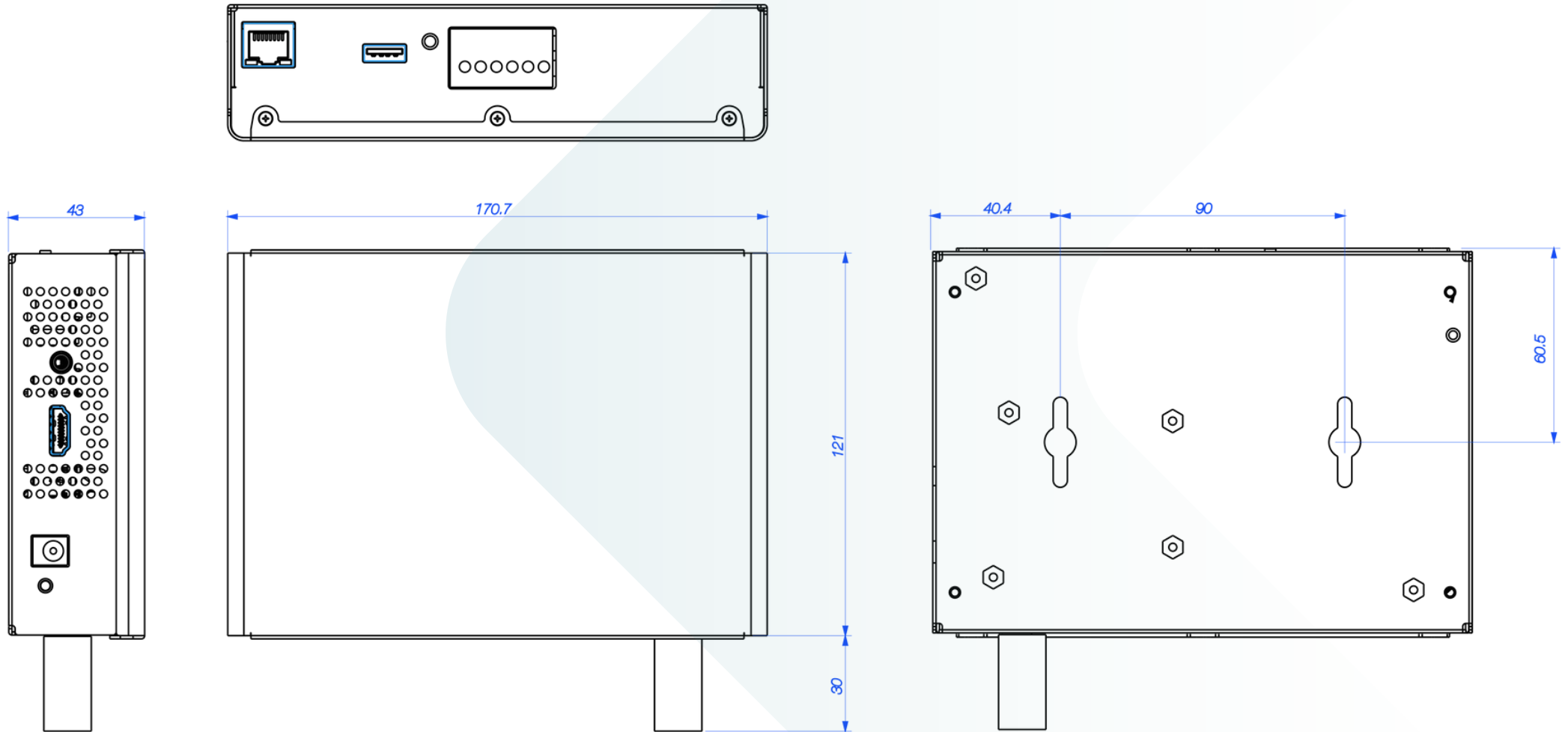

Unit: mm

Wall Mount Installation

Recommended : Install at a height within the range of human breathing (recommended height 1.5~2.5 meters).

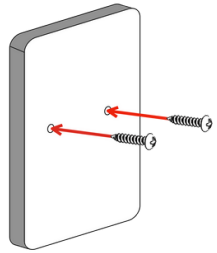

1.

Attach the installation diagram to the wall, ensuring it's horizontal. Screw in both of screws with a suitable gap from the wall.[1]

NOTE

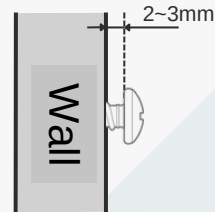

[1] Leave a 2-3 mm gap when screwing into the wall.

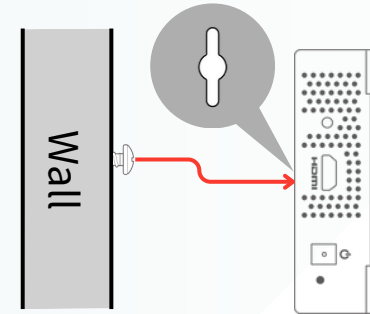

2.

Align the iAeris5's wall-mount holes with the screws and fix it to the wall.

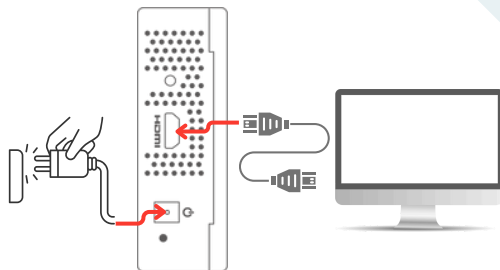

3.

Power the iAeris5 using the adapter. Connect the HDMI cable from the iAeris5 to the screen.



4.

Turn on the screen. Start monitoring air quality when the dashboard appears.

Connect to Ethernet

Aeris5 has one RJ45 Ethernet connector. Simply plug in the network cable to connect to the internet.

1

Before using Ethernet, power off iAeris5 and plug in the network cable to the RJ45 connector of iAeris5.

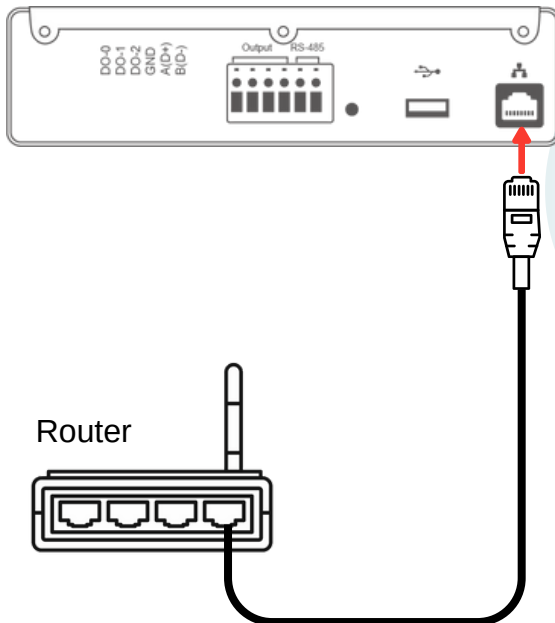

2

Power on iAeris5 until boot up completely, then press the multi-function button.

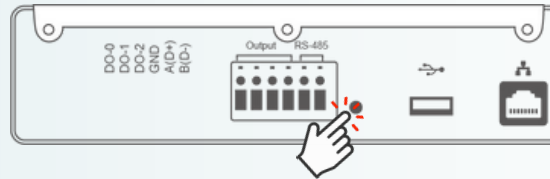

The screen shows device info. Confirm the Ethernet IP address, indicating a successful connection. Users can access iAeris5 settings via this IP.[\[1\]](#)

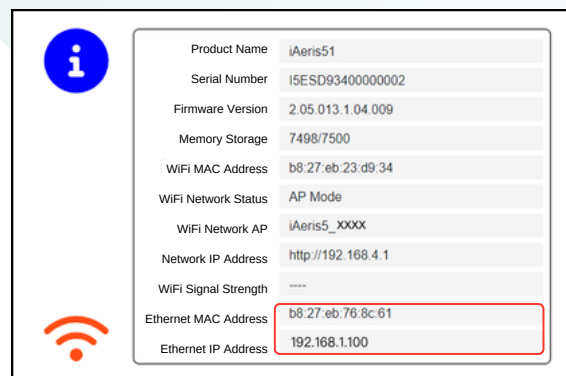

NOTE

[1] iAeris5 Ethernet defaults to DHCP. Users can set a static IP in the Ethernet settings webpage if need.

Connect to a wireless network hotspot

iAeris5's default is to enable the wireless network hotspot, allowing users to connect directly using their phone or computer.

1.

Power on iAeris5 until boot-up, then press the multi-function button.

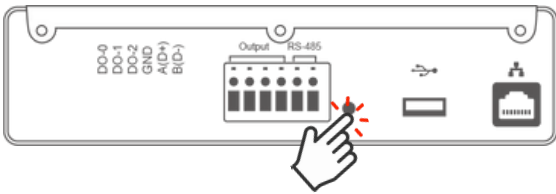

Confirm iAeris5 is in hotspot (AP) mode.^[1]

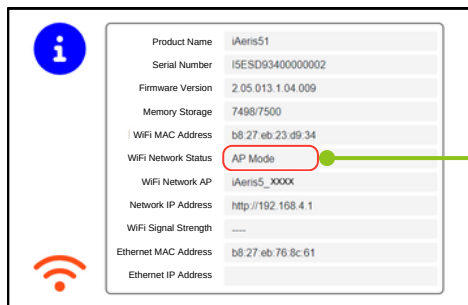

Find the WiFi hotspot and key on the the label on the side of the device.

SSID: iAeris5_xxxx

Password 1234567890

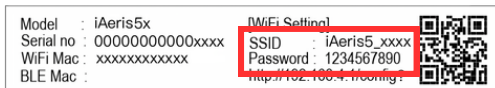

2.

Search and connect to the iAeris5 WiFi hotspot on your computer or phone

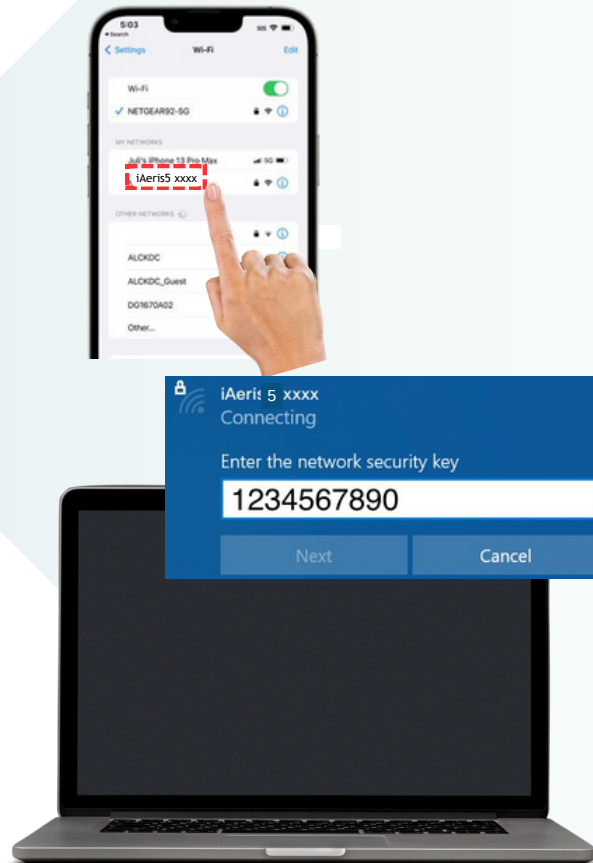

NOTE

[1] If unable to find iAeris5 WiFi hotspot, press and hold multi-function button for 10 seconds until prompt appears on screen.

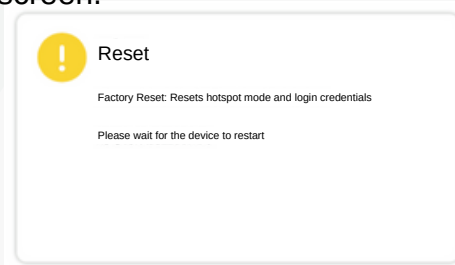

Afterward, restart to enter setup mode, and the WiFi hotspot function will automatically activate.

Login to the settings webpage

iAeris5 enables remote connection settings, accessed via computer or phone when connected to the network.



1.

Power on iAeris5 until boot-up, then press the multi-function button [1]

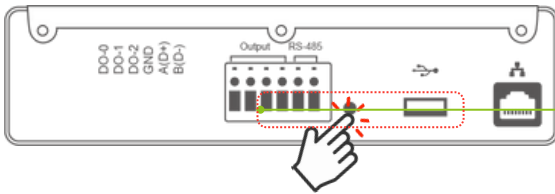

The screen shows iAeris5 connection info and network IP address.[2]

	Product Name	iAeris51
	Serial Number	I5ESD93400000002
	Firmware Version	2.05.013.1.04.009
	Memory Storage	7498/7500
	WiFi MAC Address	b8:27:eb:23:d9:34
	WiFi Network Status	connected
	WiFi Network AP	sysinno-test-AP
	Network IP Address	http://192.168.0.100
	WiFi Signal Strength	-73db
	Ethernet MAC Address	b8:27:eb:76:8c:61
	Ethernet IP Address	http://192.168.0.101

2.

Use a computer or phone's web browser and enter the network address "http://xx.xx.xx.xx" in the address bar.[3]Access the settings page.

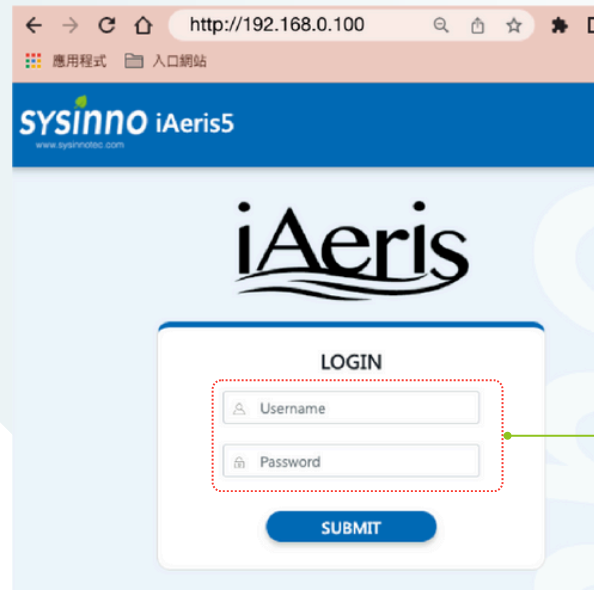

3.

Enter username and password to log in:
Factory Default
username: admin
password: admin

NOTE

- [1] For initial setup, connect to iAeris5 WiFi hotspot or Ethernet network.
- [2] Connection info shows wireless and Ethernet IP addresses. Choose alternative based on actual connection.
- [3] Use the actual IP address, "http://xx.xx.xx.xx" is just an example.

Wireless Network (WiFi) Setup

After logging in, click "Network" > "WiFi" in the menu

- 1** Choose the WiFi AP you want to connect to
- ! Note: "AP" refers to your WiFi access point. "sysinno-Zyxel" is just an example.
 - ! If iAeris5 can't find your WiFi AP, you can enter the specified "SSID" manually.

- 2** Enter the password
- ! Note: The password here is for your WiFi AP, not for iAeris5 hotspot mode. Use your WiFi AP password, not "1234567890".

- 3** Check the settings options
- ! Upload Cloud /DHCP, read the explanations on the right for individual options

- 4** Once settings are complete, click "Accept."

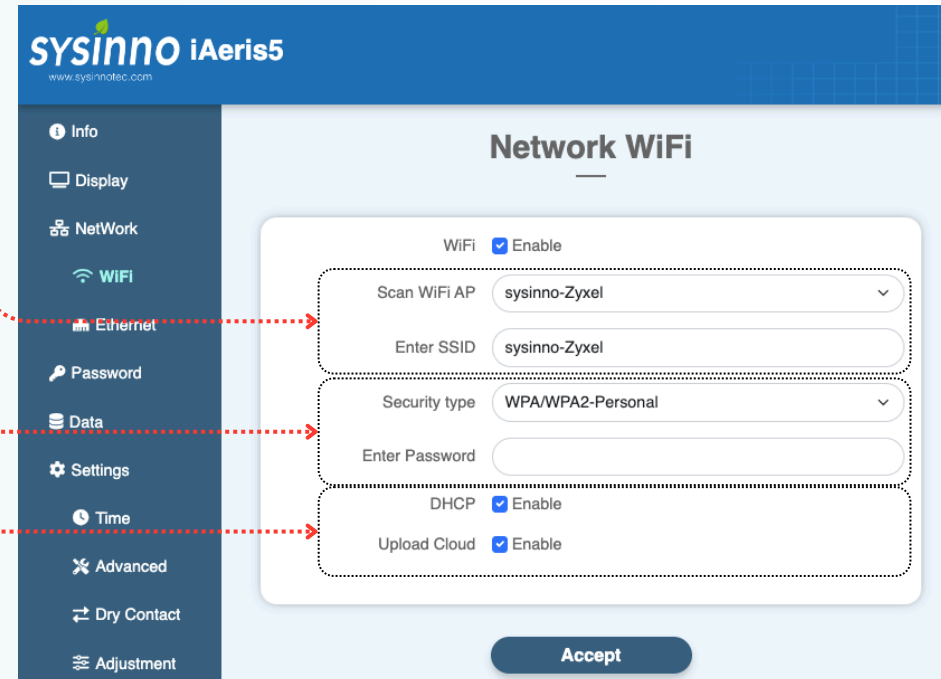

DHCP Enable Checking DHCP : IP will be assigned by AP/Router.

DHCP Enable Unchecking DHCP : the static IP assignment setup screen.

IP Address

Netmask (CIDR)

Gateway

Upload Cloud Enable Checking enables external network connection and upload data to cloud.

Wireless Network (WiFi) Setup

5 System will reboot after settings are completed.

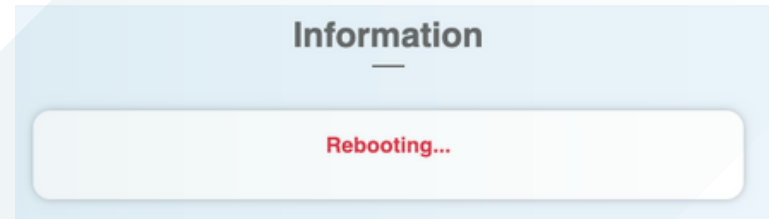

6 After Aeri5 reboot, press the multi-function button to check WiFi connection status.^[1]

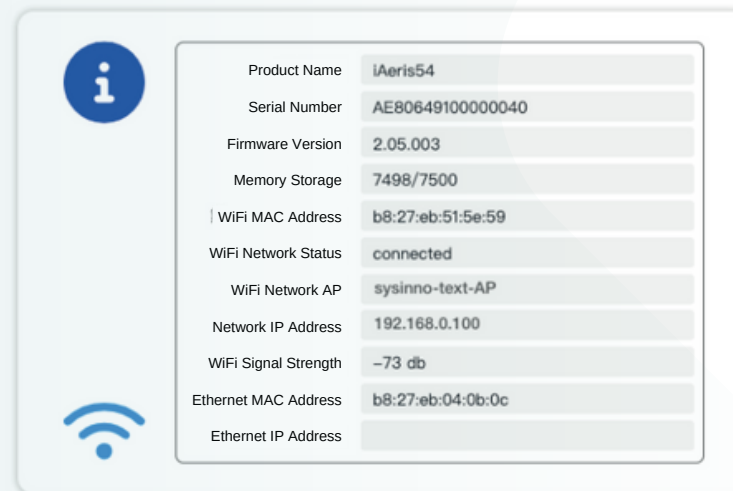

NOTE

[1] Upon successful connection, the IP Address field will show the IP. If setup fails, press and hold the multi-function button for 10 seconds to reset to factory settings, then return to step 1.

Screen template and Multimedia settings

Display Settings

1. Click **"Display"** on the menu to access display settings.
2. Select Templates[1], Language, Date format, and Time format you want.
3. You can customize your own image files for Logo, Title, and Background[2]
4. After setting, click **"Save"**. The device needs to reboot for changes to take effect.

NOTE

[[1] iAeris5 currently supports several templates, including Simple and Multimedia, for user selection.

[2] Some templates do not allow background image customization.

Settings Webpage

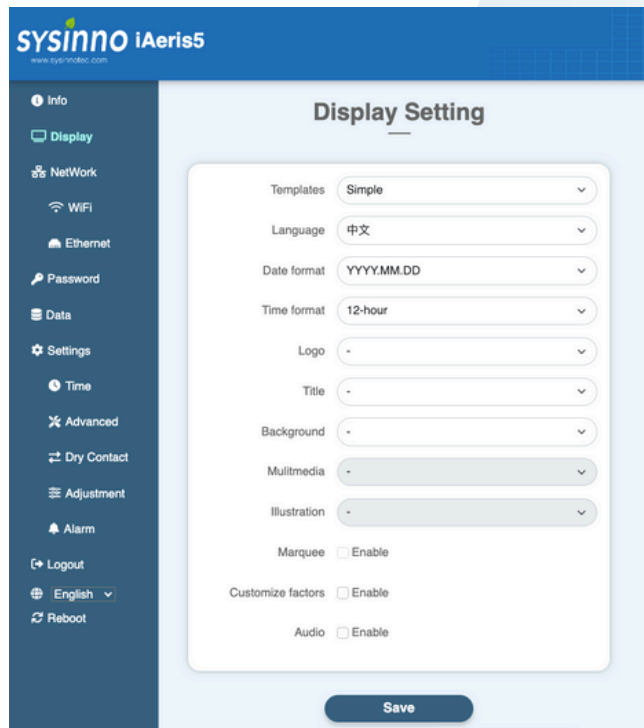

Screen

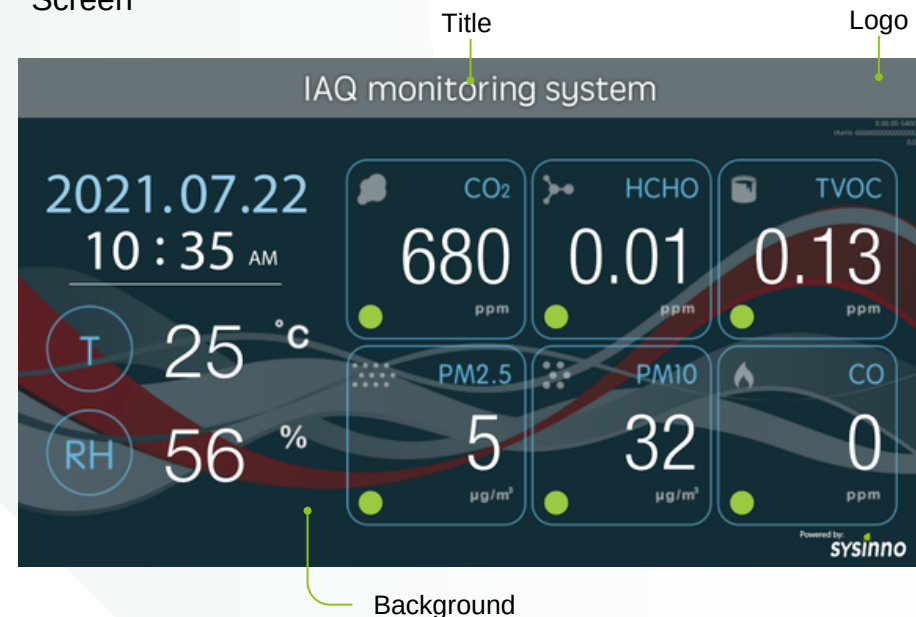

Screen template and Multimedia settings

Multimedia Template Settings

In addition to air quality monitoring, it can also play videos or photos simultaneously.

1. Select the Multimedia layout in the Templates settings.
2. In the Multimedia options menu, choose to play local media or YouTube.
3. You can select your own image files for illustrations
4. Enable subtitle scrolling (Marquee)[1] and enter the phrases content and delay time.
5. After setting, click "Save". The device needs to reboot for changes to take effect.

NOTE

[1] Subtitle scrolling (Marquee) allows entry of up to 5 sets of phrases.

Settings Webpage

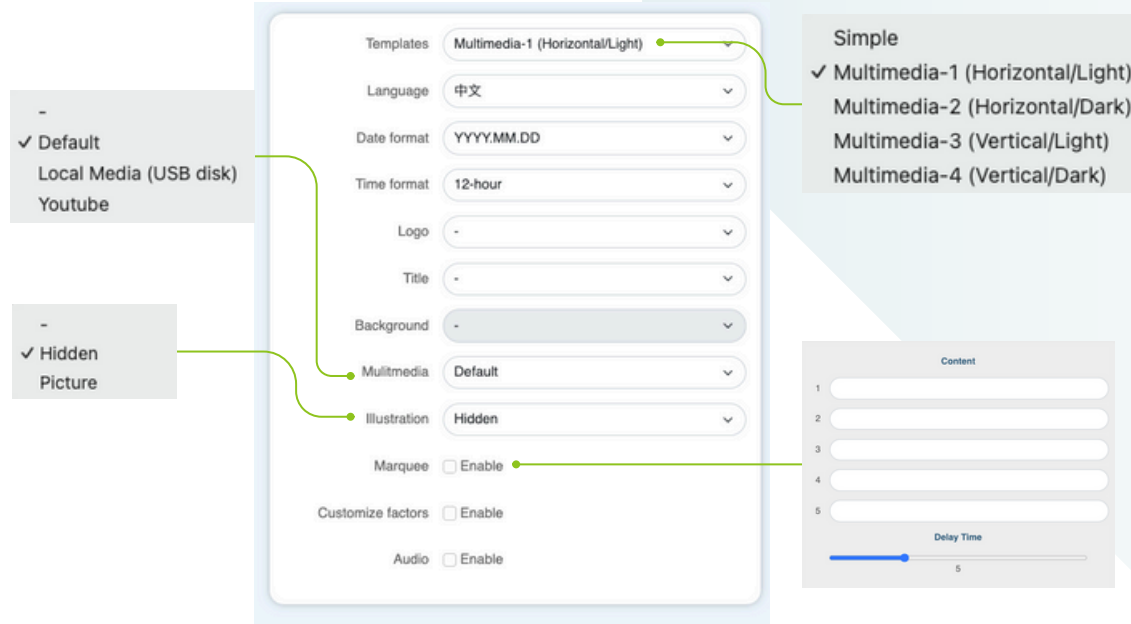

Multimedia Screen Display



Screen template and Multimedia settings

Local media Playback

1. Select local media playback in the multimedia options
2. Prepare a suitable capacity USB drive (iAeris5 supports FAT32, ExFAT, and NTFS formats).
3. Place the multimedia files [2] in the root directory of USB drive [1].
4. Insert the USB drive into iAeris5's USB port and reboot
5. After rebooting, iAeris5 will automatically play the files of the USB drive.

Setting webpage

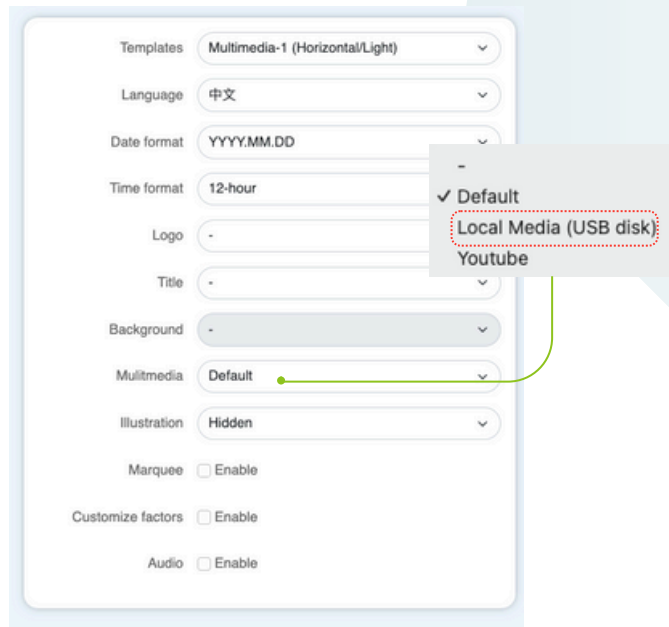

NOTE

- [1] Multimedia files must be in the root directory for play correctly.
- [2] Multimedia file formats : jpg/jpeg, png, bmp, mp4, mov, gif

USB drive

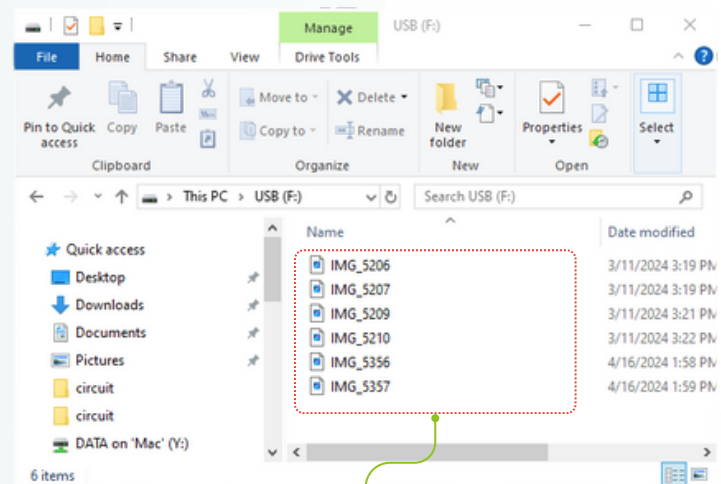

Multimedia files

Screen template and Multimedia settings

YouTube video Playback

1. Select YouTube in the multimedia options.
2. Open the YouTube website in a browser, find the video or playlist[1], and copy the YouTube URL
3. Paste the YouTube URL[2] into the "YouTube URL" field.
4. After setting, click "Save". After rebooting, iAeris5 will automatically play the YouTube video.

NOTE

- [1] Please create a playlist on the YouTube website.
- [2] Due to commercial and copyright reasons, some YouTube videos may not play properly.

setting webpage

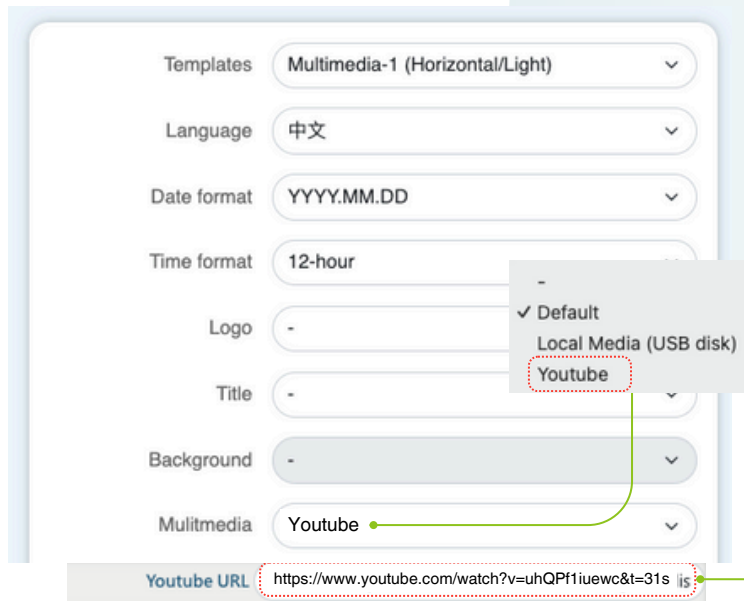

YouTube website



Advanced Settings

In addition to the aforementioned "Wireless Network" and "Screen template and Multimedia settings", the settings webpage also provides the other functions and explain in this section.

Device Information

1. Click "Info" on the menu.
2. View detailed information about iAeris5.



Change Username and Password

1. Click "Password" in the menu to access the username and password settings page.
2. Change the user name[1]
3. Change the password[2] and confirm the new password.
4. After setting the password, the page will automatically log out.

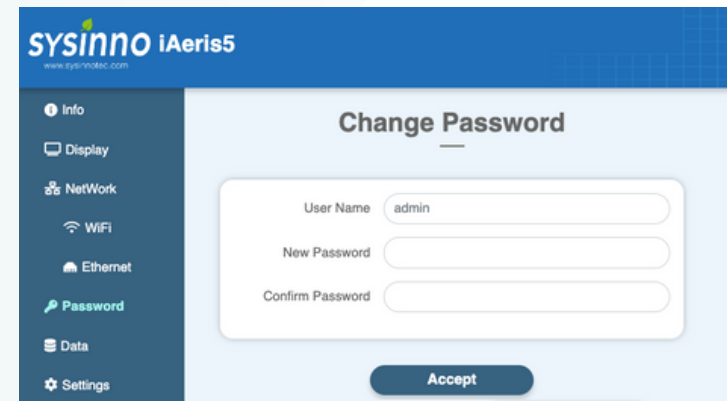

NOTE

- [1] If forgot username and password, press and hold the multi-function button for 10 seconds to switch to factory hotspot mode and reset the login.
- [2] Passwords must be at least 8 characters.

Advanced Settings

Device Time Settings

1. Click "Settings" -> "Time" in the menu to enter the time settings page.
2. Enable NTP [1]: Enable network time synchronization service and set the time zone, or set the time server address manually.
3. Disable network time synchronization, manually set device time: Uncheck the option of network time synchronization, then set the device time and date manually.
4. Set device sleep cycle[2]: Define start and end times, HDMI can be turned off during this period.

NOTE

[1] iAeris5 needs an internet connection for network time synchronization.

[2] iAeris5 will keep monitors air quality during sleep cycle (HDMI turn off).

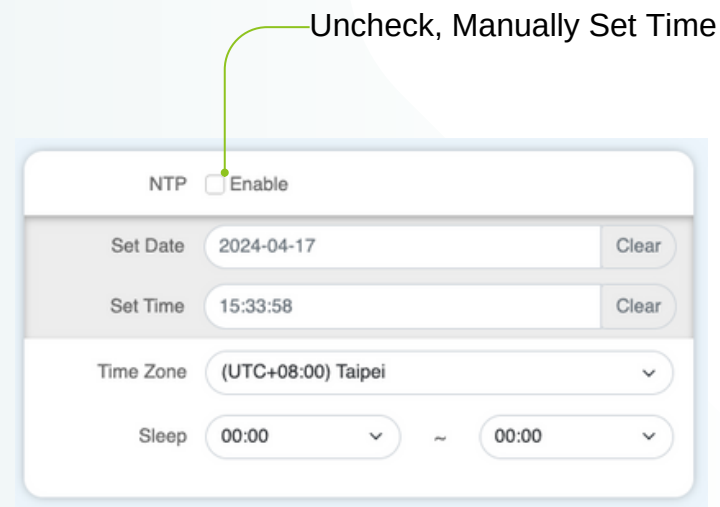
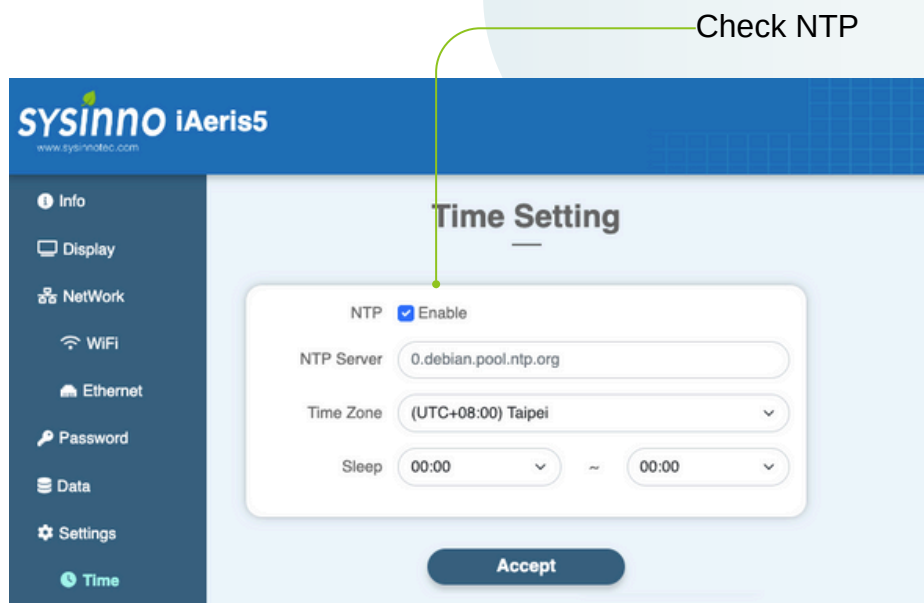

Advanced Settings

Device Data Download

1. Click "**Data**" in the menu to enter the data download page
2. Select the export start and end times, choose the data type^[1] and click "**Download**".
3. Choose the location to save the file^[2]

NOTE

[[1] Users can choose the data type based on the purpose, including raw data, hourly average, and daily average.

[2] The exported type is CSV file.

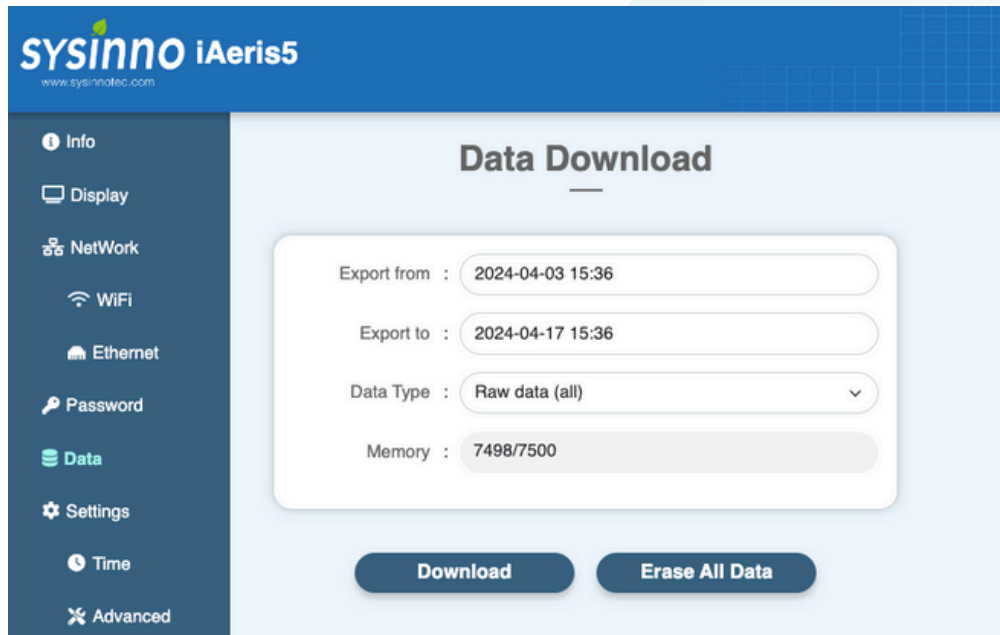

The screenshot shows the 'Data Download' interface of the sysinno iAeris5 device. The page has a blue header with the sysinno logo and 'iAeris5' text. A dark blue sidebar on the left contains a menu with options: Info, Display, NetWork, WiFi, Ethernet, Password, Data (highlighted), Settings, Time, and Advanced. The main content area is titled 'Data Download' and contains a white form with the following fields: 'Export from' (2024-04-03 15:36), 'Export to' (2024-04-17 15:36), 'Data Type' (Raw data (all) with a dropdown arrow), and 'Memory' (7498/7500). Below the form are two buttons: 'Download' and 'Erase All Data'.

Cloud Platform Interface (Optional)

Go to <https://xsize.net/iaeris/login.php> in your browser.



Cloud Platform Interface (Optional)

Register Account



The screenshot shows the registration page for iAeris Air Quality Monitor. The header is dark teal with the iAeris logo and 'Air Quality Monitor' text. On the right side of the header, there are links for '中文', 'Login', and 'Register', with a hand cursor icon pointing to the 'Register' link. The main content area has a light blue background with a dandelion seed head. The title 'Register account' is centered. Below the title are five input fields: 'Account, registered email address', 'Password, 10 or more English, Number...', 'Confirm the password and enter the password', 'Member name, please enter a name', and 'please select monitor type' with a dropdown arrow.

Historical Data Trend Curve

- Click "Sensing Factors" on the homepage to access the historical curve interface.

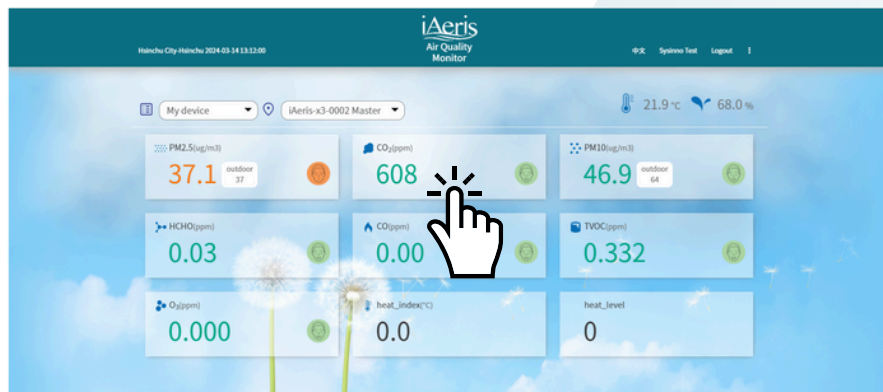

- This page shows hourly averages and up to seven days of sensing data.



Customer Area Functionality

- The cloud platform provides customer-oriented features for data recording and managing easily.
- Before service expires, contact the device vendor to purchase additional usage years for continued data download functionality.

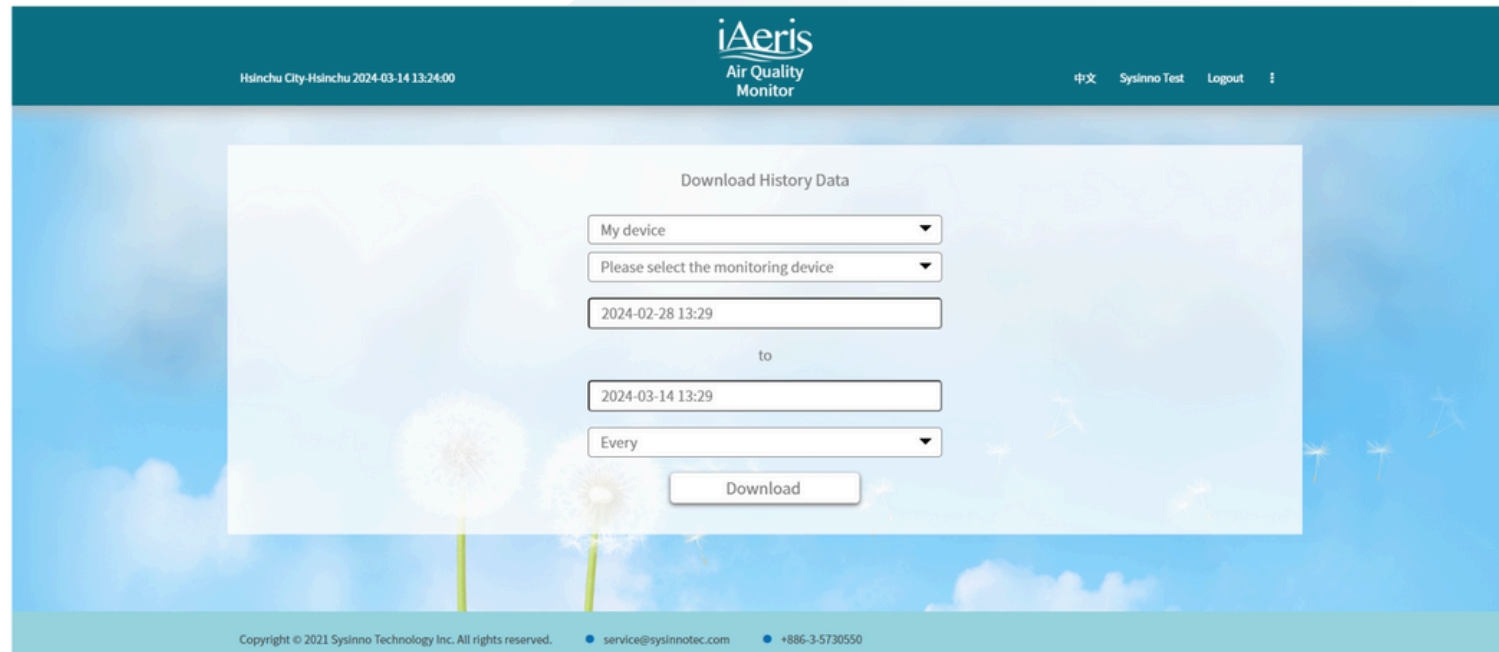

The screenshot displays the 'iAeris Air Quality Monitor' web interface. The header includes the location 'Hsinchu City-Hsinchu' and the date '2024-03-14 13:24:00'. The main content area is titled 'Download History Data' and contains the following form elements:

- A dropdown menu with 'My device' selected.
- A dropdown menu with the text 'Please select the monitoring device'.
- A date input field containing '2024-02-28 13:29'.
- The word 'to' centered between two date input fields.
- A date input field containing '2024-03-14 13:29'.
- A dropdown menu with 'Every' selected.
- A 'Download' button.

The footer contains the following text: 'Copyright © 2021 Sysinno Technology Inc. All rights reserved. • service@sysinnotec.com • +886-3-5730550'.

Installation Position Recommendations

For accuracy, we recommend installing one detector for every 200 square meters of enclosed space.

For example:

- Each open space of 200 square meters requires one detector.
 - Each individual partitioned meeting room or space requires one detector.
 - For spaces larger than 200 square meters, consider installing multiple detectors throughout the entire area to achieve optimal coverage.
 - Detectors should be installed near indoor areas where people are active or near ventilation (air conditioning) equipment return air vents.
 - Detector placement should be away from operable doors, windows, and air conditioning vents, at least 2 meters away.
-
- We recommend installing the detector at a height of 1.5 meters to 2.5 meters.
 - Position the detector at least 2 meters away from doors, windows, and air vents.
 - Ensure that the device's ventilation holes are not obstructed, allowing for proper airflow.
 - To ensure accuracy and longevity, ceiling-mounted installation on the ceiling is not recommended.

- This product provides general indoor air quality information only and is not intended to determine individual health impacts or serve as a fire alarm.
- Keep the product away from heat sources and areas prone to water splashes or dripping.
- Avoid using the product in environments with vibrations or direct sunlight.
- Ensure proper airflow by not blocking the ventilation holes around the device.
- Do not insert external objects into the ventilation holes to prevent sensor malfunction or electric shock.
- Non-technical personnel should not attempt to disassemble, modify, or repair the product.
- Use correct connectors and cables during installation and avoid forcing connectors into ports to prevent damage not covered by warranty.

【 Attention 】 Power Supply Notice:

This product can be powered using the included power adapter or Ethernet network via PoE (Power over Ethernet). (PoE power supply is optional)

Power Supply Specifications:

The included adapter outputs 5V DC with a DC Jack (Ø2.5mm) connector. Do not modify or extend the power adapter cable arbitrarily, as it may damage the equipment.

For PoE power supply, this product follows the IEEE802.3af standard, with an input voltage range of 36V to 57V and a rated power of 10W. Please use compliant power sourcing equipment (PSE) for power supply.

【 Attention 】

- This product supports energy recovery ventilation (ERV) and single-directional intake fans. Before purchasing, consult local distributors for compatibility and technical support.
- The control logic for RS485 or dry contact output is fixed and intended only for ventilation equipment control.

Dry Contact Specification

This product supports three sets of independent dry contact points (DO-0, DO-01, DO-02). Dry contacts are electronic passive normally open switches with a rated voltage resistance of DC 24V and a current resistance of 0.5A. The voltage at the endpoints of DO-0, DO-01, and DO-02 must be higher than the voltage at the COM endpoint. Do not operate directly using AC power. High-voltage devices must be driven through relays.

Use the correct connectors and ports

- Avoid forcing connections. Check for obstructions. Ensure proper alignment.
- Damage from mishandling, like inserting wrong pins, isn't covered by warranty.

Prohibited Live Operations

When changing power and port terminals, make sure to disconnect the power before wiring. After completing the settings, reconnect the power.